

**PROGRAMMABLE
DIGITAL REFRACTOMETER**

300037

INSTRUCTION MANUAL

SPER
SCIENTIFIC

Environmental Measurement Instruments

CONTENTS

INTRODUCTION	2
PANEL DESCRIPTION.....	3
FACEPLATE & LCD DISPLAY	3
OPERATING INSTRUCTIONS	
General Measurement	4
Calibration Procedures.....	4
Zero Checking.....	4
PARAMETER SETTINGS	
Changing Temperature Scale.....	5
Automatic Temperature Compensation	5
Scale Selection	5
High/Low Range Limit Alert.....	5
ERRATIC READINGS	6
BATTERY REPLACEMENT	7
PRECAUTIONS.....	7
SPECIFICATIONS	8
WARRANTY	8

INTRODUCTION

A Refractometer operates on the principle that, as the concentration or density of a solution increases, its refractive index changes proportionately. The larger the concentration of dissolved substances in the solution, the higher the reading.

This high precision instrument is designed for laboratory accuracy. The digital readout eliminates uncertainties, while the water resistant design facilitates clean ups and protects the electronics from moist environments. The large display provides clear readout for measurements and the sample temperature in addition to their other parameters.

Features include a wide measurement range, automatic temperature compensation (ATC), °C/°F selectable scales, high/low range limit alerts, auto shut-off and a low battery indicator. This Refractometer has built-in Brix% and nD scales.



Do not connect or disconnect the USB cable while the Refractometer is turned on.

PANEL DESCRIPTION

- | | |
|-------------------------------|-----------------------|
| 1. High/Low Range Limit Alert | 7. LCD |
| 2. READ and Enter | 8. Prism plate |
| 3. ZERO and ◀ | 9. Prism |
| 4. SCALE and ▼ | 10. Cover |
| 5. FUNC and Y/N | 11. 9V DC Power Input |
| 6. ON and OFF | 12. USB Data Port |

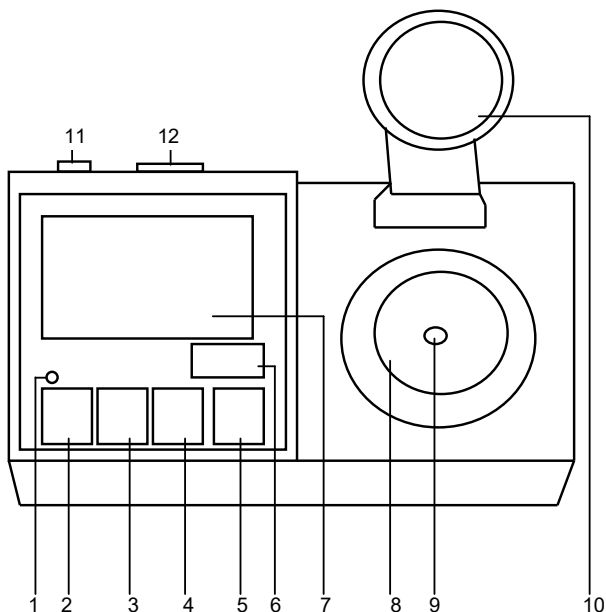

FACEPLATE & LCD DISPLAY

1. Prism Temperature
2. ATC (active)
3. High Limit Alert
4. Low Limit Alert
5. Low Battery
6. Measurement Value
7. Calibration Error
8. Scale Indicator
9. Red LED

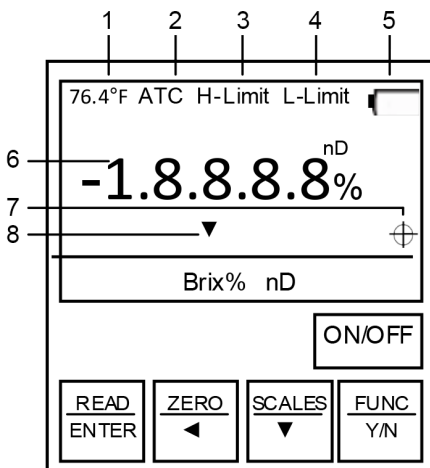

OPERATING INSTRUCTIONS

General Measurement

- To avoid damage, it is important to clean the **PRISM WINDOW** before and after each use.
- Press the **ON/OFF** button to turn the Refractometer ON. The unit will automatically shut off after about 3 minutes of inactivity.
- Perform the Calibration Procedure
- With the unit on, fill the **PRISM WINDOW** with the sample to be measured and then close the **COVER**.
- Press the **READ** button immediately to ensure accurate readings. Delays may cause the sample to evaporate.

Calibration Procedure

- Clean the **PRISM WINDOW** before and after each use.
- Fill the **PRISM WINDOW** with a standard solution such as distilled or deionized water. The ideal temperature of the solution and the unit should be 65° to 72°F (18° to 22°C).
- Close the **COVER**.
- Press the **ON/OFF** button to turn the unit **ON**.
- Press the **ZERO** button for 3 seconds.
- When the procedure is complete, **CAL** will be displayed.
- To check the **nD** value, press the **ZERO** button once.
- This data can be viewed at any time to show the last calibration value.
- A flashing crosshair symbol is displayed when the calibration solution falls outside the accepted range.

Zero Checking

- Fill the prism window with distilled water solution that is at the same temperature as the solution to be tested.
- Close the **COVER**
- With the unit on, press the **ZERO** button. A refractive index reading between 1.3329 to 1.3331 indicates that the unit accurately reads to the calibrated zero point.
- If the unit is out of range, a flashing crosshair symbol will be displayed, indicating that recalibration is required.

- Press any other button to exit this function.
- Perform Zero Checking if the unit has sustained a shock, is subjected to temperature changes, or seems inaccurate.

PARAMETER SETTINGS

Changing the Temperature Scale

- With the unit on, press the **FUNC** button as needed until t.P C (or F) is displayed. Press the **SCALE** button to view the temperature in Fahrenheit (or Celsius). Press the **READ** button to exit.

Automatic Temperature Conversion

- This makes manual temperature correction unnecessary, but to obtain precise readings the sample and unit should be at similar ambient temperatures. ATC appears on the LCD when this function is activated. To set the ATC function, press the **FUNC** button as needed until ALC.Y (or N) appears. Press the **SCALE** button to toggle between on or off. Press the **READ** button twice to exit.

Scale Selection

- Press the **SCALE** button to toggle through the scales. The ▼ symbol indicates the active scale.

High/Low Range Limit Alert

Setting High Range Alert

- With the unit on, press the **FUNC** button as needed until *HL* Y and the flashing H-Limit icon is displayed.
- Press the **READ** button and the last digit flashes.
- Use the q and the t buttons to set the high range limit.
- Press the **READ** button to activate the function.
- Press the **FUNC** button as needed to return to the measurement screen.

Deactivating High Range Alert

- Press the **FUNC** button as needed until HL n appears.
- Press the **READ** button and the last digit flashes.
- Press the **FUNC** button as needed to return to the measurement screen.

Setting Low Range Alert

- With the unit on, press the **FUNC** button as needed until LL Y and the flashing L-Limit icon appear.
- Press the **READ** button and the last digit flashes.
- Use the q and t buttons to set the low range limit.
- Press the **READ** button activate the function.
- Press the **FUNC** button as needed to return to the measurement screen.

Deactivating Low Range Alert

- Press the **FUNC** button as needed until LL n appears.
- Press the **READ** button and the last digit flashes.
- Press the **FUNC** button as needed to return to the measurement screen.

ERRATIC READINGS

- A. If the readings are significantly above or below the expected results, consider the following:
- B. Sample contains more than one dissolved solid.

For example: if the sample contains both salt and sugar, a Brix Refractometer will not display the true sugar content because the salt content will skew the Brix measurement.

- C. When diluting samples, be sure to use a pure solution such as distilled water.
- D. Sample contains suspended solids. Filter and thoroughly mix the sample before testing.
- E. Perform a calibration and check the zero point.
- F. Replace the battery.

- G. Outside light can cause erratic readings, make sure to close the **COVER** to the **PRISM** during measurement.

BATTERY REPLACEMENT

- A. When the battery is low,  the above symbol appears on the LCD.
- B. Open the back cover to replace the 9V battery.
- C. Reinsert the back cover, making sure it is properly seated. A built-in gasket protects the circuitry from spills.

PRECAUTIONS

- A. Turn off the unit before connecting the AC power adapter.
- B. Protect the LCD from exposure to strong light sources.
- C. Avoid prolonged use or storage in extreme temperatures.
- D. Clean the prism and window surfaces before and after use with a soft wet clean cloth or paper towel. Other surfaces may be cleaned with a mild liquid dish detergent and water.
- E. Do not use in corrosive environments.
- F. Do not submerge the unit.
- G. This precision measuring instrument contains delicate optics and electronics. Handle with care and do not drop.
- H. To avoid electric shock, make sure the battery compartment is covered and do not disassemble the unit.

SOFTWARE DOWNLOAD

You can now download the software that came with your meter directly on your computer.

1. Go to **www.sperdirect.com** and search for your meter (**300037**).
2. Once you are on the Product Page, scroll down past the blue bar and look for the **Software Download icon** on the right side of the page.

SPECIFICATIONS

Type	Range	Res.	Accuracy
Brix	0 to 95.0%	0.1%	±0.2%
nD	1.3330 to 1.5318	0.0001	±0.001
Temperature	0 to 40°C	0.1°C	±1°C
	-32 to 104°F	0.1°F	±2°F

Power Supply:	9V Battery (apx. 5000 tests/battery) DC Input (AC Power Adapter)
Weight:	18 oz (500 g)
Dimensions:	7" x 4" x 2½" (180 x 100 x 65 mm)
Operating Temp:	41 to 95°F (5 to 35°C)
Storage Temp:	14 to 122°F (-10 to 50°C)
Included:	Instructions, Carrying Case, 9V Battery, AC Power Adapter, USB Cable, Distilled Water, and Transfer-Pipette. Software download available at www.sperdirect.com

WARRANTY

Sper Scientific warrants this product against defects in materials and workmanship for a period of **one (1) year** from the date of purchase, and agrees to repair or replace any defective unit without charge. If your model has since been discontinued, an equivalent Sper Scientific product will be substituted if available. This warranty does not cover probes, batteries, battery leakage, or damage resulting from accident, tampering, misuse, or abuse of the product. Opening the meter to expose its electronics will void the warranty. To obtain warranty service, ship the unit postage prepaid to:

SPER SCIENTIFIC LTD.
8281 E. Evans Rd., Suite #103
Scottsdale, AZ 85260
(480) 948-4448

The defective unit must be accompanied by a description of the problem and your return address. Register your product online at www.sperwarranty.com within 10 days of purchase.